

ejotherm STR-tool 2GS

Specially developed tool with patented adjustment mechanism for countersunk installation using to EJOT STR principle

Fastening of insulation boards



EJOT STR principle



Effortless hole drilling due to minimal drill hole depth



Insert the anchor with pre-assembled screw into the drill hole until the washer rests slightly on the surface



Installation with STR-tool 2GS: the hole is automatically formed



insert ejotherm STR cap into the hole...



push it flush with the surface using a float



Done! Now the surface completely flat, ready for rendering.

Advantages

- ❑ Specially developed tool for countersunk installation of *ejotherm* STR U 2G
- ❑ Also compatible for use with *ejotherm* STR U and *ejotherm* STR H
- ❑ Adjustment shaft with hex shank for easy use with standard drills
- ❑ Patented mechanism enables quick and easy adjustment to the required anchor length
- ❑ Easy conversion from *ejotherm* STR-tool 2GS for surface fixed installation
- ❑ For reliable and easy installation using to the EJOT STR principle
- ❑ Robust design for long service life
- ❑ Worn parts can be changed quickly
- ❑ Set contains: *ejotherm* STR-tool 2GS, additional cutting discs, offset screw driver as well as bits for all applications

ejothem STR-tool 2GS

Specially developed tool with patented adjustment mechanism for countersunk installation using to EJOT STR principle

Fastening of insulation boards

Adjustment shaft SDS-plus

- Alternative adjustment shaft with SDS-plus for *ejothem* STR-tool 2GS



ejothem STR-tool 2GS applications

ejothem STR U 2G

Countersunk installation:
Adjustment shaft assembled with base element and TORX-Bit T30 for all lengths

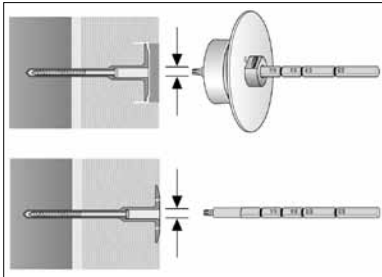

Surface fixed installation:
Adjustment shaft assembled with TORX-Bit T30 for all lengths

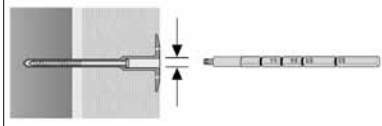

ejothem STR U

Vertiefte Montage:
Adjustment shaft assembled with base element and TORX-Bit T30 for all lengths

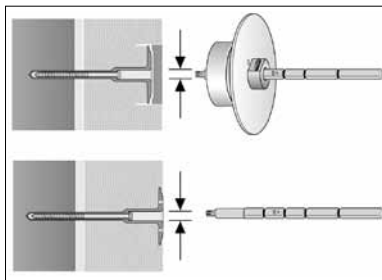

Surface fixed installation:
Adjustment shaft assembled with TORX-Bit T30 for all lengths

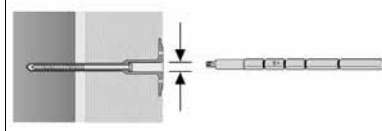

ejothem STR H

Countersunk installation:
Adjustment shaft assembled with base element and TORX-Bit T25 for all lengths

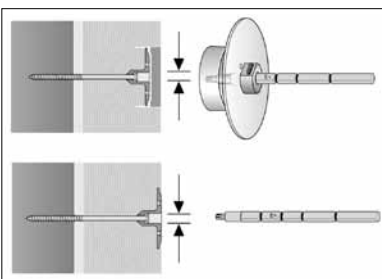

Surface fixed installation:
Adjustment shaft assembled with TORX-Bit T25 for all lengths

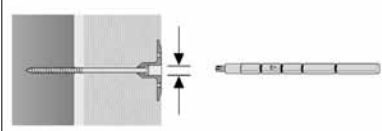

ejothem VT 2G & STR U 2G

Countersunk installation:
Adjustment shaft assembled with TORX-Bit T30 for all lengths

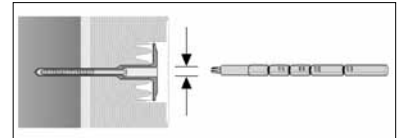

Length adjustment

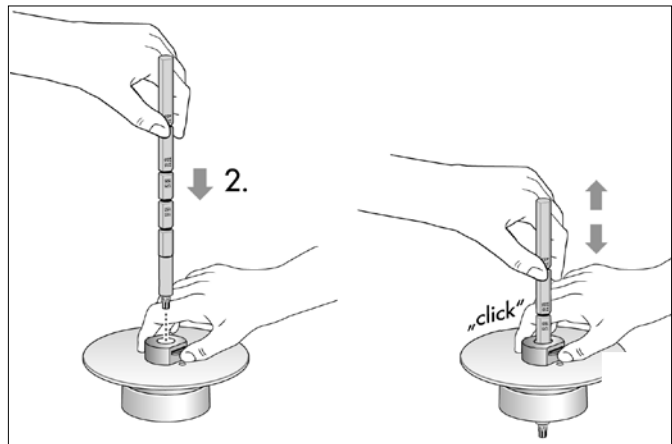

Product range

Description	Product code	Packaging unit (pieces)
<i>ejothem</i> STR-tool 2GS	9129 000 000	1
<i>ejothem</i> adjustment shaft SDS-plus	9129 000 005	1